



KERN & Sohn GmbH

Ziegelei 1
D-72336 Balingen
E-Mail: info@kern-sohn.com

Phone: +49-[0]7433-9933-0
Fax: +49-[0]7433-9933-149
Internet: www.kern-sohn.com

Operating manual

Floor scales

KERN BIC

Version 1.0
09/2016
GB

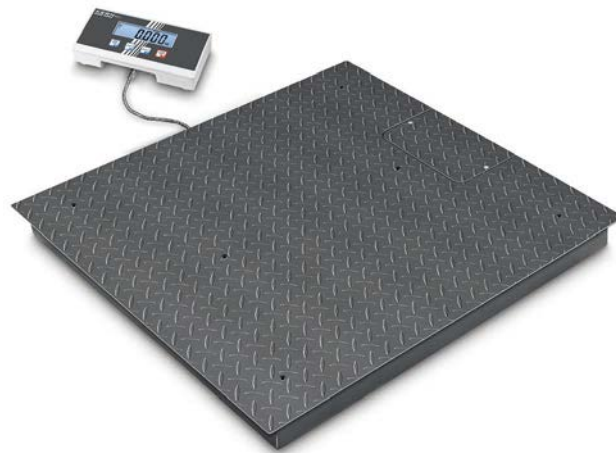

BIC-BA-e-1610



KERN BIC

Version 1.0 09/2016

Operating instructions Floor scales

Contents

1	Technical data	4
2	Appliance overview display unit	6
2.1	Keyboard overview	7
3	Basic Information (General)	7
3.1	Proper use	7
3.2	Improper Use	7
3.3	Warranty	8
3.4	Monitoring of Test Resources	8
4	Basic Safety Precautions	9
4.1	Pay attention to the instructions in the Operation Manual	9
4.2	Personnel training	9
5	Transport and storage	9
5.1	Testing upon acceptance	9
5.2	Packaging / return transport	9
6	Unpacking and placing	10
6.1	Installation Site, Location of Use	10
6.2	Unpacking/installation	10
6.3	Scope of delivery / serial accessories:	10
6.4	Mains connection	10
6.5	Adjustment	11
7	Operation	13
7.1	Start-up	13
7.2	Switching Off	13
7.3	Zeroing	13
7.4	Simple weighing	13
7.5	Weighing with tare	14
7.6	Hold function (animal weighing function)	15
8	Menu	16
8.1	Navigation in the menu	16
8.2	Menu overview	17
9	Servicing, maintenance, disposal	18
9.1	Cleaning	18

9.2	Servicing, maintenance.....	18
9.3	Disposal.....	18
10	Error messages, troubleshooting guide	19
11	Declaration of conformity	20

1 Technical data

KERN	BIC 600K-1S	BIC 600K-1	BIC 1T-4S
Readability (d)	100 g; 200 g	100 g; 200 g	200 g; 500 g
Weighing range (max)	300 kg; 600 kg	300 kg; 600 kg	600 kg; 1,500 kg
Reproducibility	100 g; 200 g	100 g; 200 g	500 g
Linearity	± 300g; 600 g	± 300g; 600 g	± 1 kg
Recommended adjustment weight, not added (class)	600 kg (M2)	600 kg (M2)	1.5t (M2)
Warm-up time	10 minutes		
Stabilization time (typical)	2 s		
Weighing unit	kg, lb		
Auto Off	3 min.		
Ambient temperature	-10°C – 40°C		
Humid environment	0 % - 80 % (non-condensing)		
Electric Supply	Input voltage 100 V - 240 V, 50 / 60 Hz		
	Power pack secondary voltage 9V, 100mA		
Dimensions display unit (B x D x H) mm	235 x 114 x 51	235 x 114 x 51	235 x 114 x 51
Weighing surface mm	1000 x 1000	1200x1500	1000 x 1000
Net weight kg	130	150	130



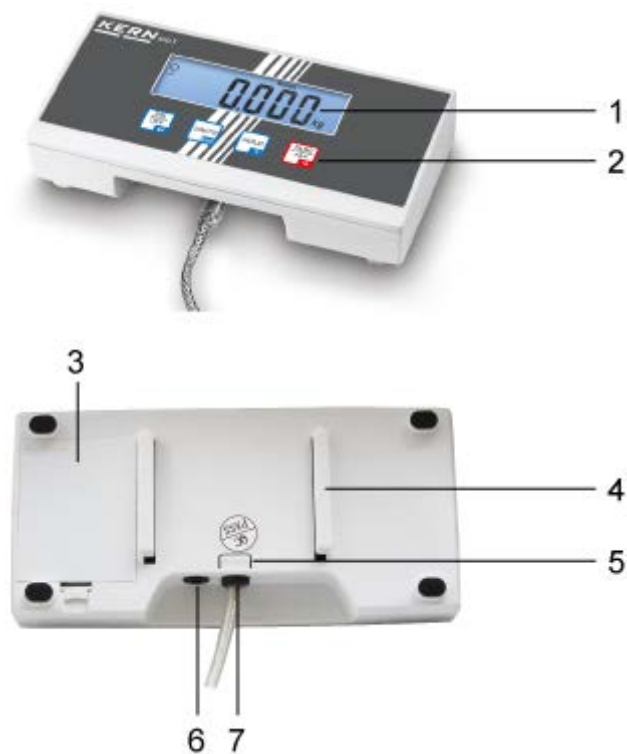

KERN	BIC 1T-4	BIC 3T-3	BIC 3T-3L
Readability (d)	200 g; 500 g	500 g; 1,000 g	500 g; 1,000 g
Weighing range (max)	600 kg; 1,500 kg	1,500 kg; 3,000 kg	1,500 kg; 3,000 kg
Reproducibility	500 g	500 g; 1,000 g	500 g; 1,000 g
Linearity	± 1 kg	± 1.5 kg; 3 kg	± 1.5 kg; 3 kg
Recommended adjustment weight, not added (class)	1.5t (M2)	3000 kg (M2)	3000 kg (M2)
Warm-up time	10 minutes		
Stabilization time (typical)	2 s		
Weighing unit	kg, lb		
Auto Off	3 min.		
Ambient temperature	-10°C – 40°C		
Humid environment	0 % - 80 % (non-condensing)		
Electric Supply	Input voltage 100 V - 240 V, 50 / 60 Hz		
	Power pack secondary voltage 9V, 100mA		
Dimensions display unit (B x D x H) mm	235 x 114 x 51	235 x 114 x 51	235 x 114 x 51
Weighing surface mm	1200×1500	1200×1500	1500 x 1500
Net weight kg	150	150	150

2 Appliance overview display unit



1. Weight display
2. Buttons
3. Battery compartment
4. Guide rail support base / stand
5. End stop support base / stand
6. Mains adapter connection
7. Connection load cell cable

2.1 Keyboard overview

Button	Function
	Turn on/off balance
	Hold/ animal weighing function
	Tare balance
	Switch-over weighing unit Back to weighing mode, or menu

3 Basic Information (General)

3.1 Proper use

The display unit acquired by you is used in combination with a weighing plate and serves to determine the weighing value of material to be weighed. It is intended to be used as a “non-automatic weighing system”, i.e. the material to be weighed is manually and carefully placed in the centre of the weighing plate. As soon as a stable weighing value is reached the weighing value can be read.

3.2 Improper Use

Do not use display unit for dynamic weighing. In the event that small quantities are removed or added to the material to be weighed, incorrect weighing results can be displayed due to the “stability compensation“ in the display unit. (Example: Slowly draining fluids from a container on the balance.)

Do not leave permanent load on the weighing pan. This may damage the measuring system.

Impacts and overloading exceeding the stated maximum load (max) of the weighing plate, minus a possibly existing tare load, must be strictly avoided. Both, the weighing plate and the display unit may be damaged during this process.

Never operate display unit in explosive environment. The serial version is not explosion protected.

Changes to the display unit's design are not permitted. This may lead to incorrect weighing results, safety-related faults and destruction of the display unit.

The display unit may only be operated in accordance with the described default settings. Other areas of use must be released by KERN in writing.

3.3 Warranty

Warranty claims shall be voided in case

- Our conditions in the operation manual are ignored
- The appliance is used outside the described uses
- The appliance is modified or opened
- Mechanical damage or damage by media, liquids, natural wear and tear
- The appliance is improperly set up or incorrectly electrically connected
- The measuring system is overloaded

3.4 Monitoring of Test Resources

In the framework of quality assurance the measuring-related properties of the display unit and, if applicable, the testing weight, must be checked regularly. The responsible user must define a suitable interval as well as type and scope of this test. Information is available on KERN's home page (www.kern-sohn.com) with regard to the monitoring of display units' test substances and the test weights required for this. In KERN's accredited DKD calibration laboratory test weights and display units may be calibrated (return to the national standard) fast and at moderate cost.

4 Basic Safety Precautions

4.1 Pay attention to the instructions in the Operation Manual



Carefully read this operation manual before setup and commissioning, even if you are already familiar with KERN balances.

4.2 Personnel training

The appliance may only be operated and maintained by trained personnel.

5 Transport and storage

5.1 Testing upon acceptance

When receiving the appliance, please check packaging immediately, and the appliance itself when unpacking for possible visible damage.

5.2 Packaging / return transport



- ⇒ Keep all parts of the original packaging for a possibly required return.
- ⇒ Only use original packaging for returning.
- ⇒ Prior to dispatch disconnect all cables and remove loose/mobile parts.
- ⇒ Reattach possibly supplied transport securing devices.
- ⇒ Secure all parts such as the glass wind screen, the weighing platform, power unit etc. against shifting and damage.

6 Unpacking and placing

6.1 Installation Site, Location of Use

The display units are designed in a way that reliable weighing results are achieved in common conditions of use.

Precise and fast work is achieved by selecting the right place for your display unit and your weighing plate.

On the installation site observe the following:

- Place the display unit and the weighing plate on a stable, even surface.
- Avoid extreme heat as well as temperature fluctuation caused by installing next to a radiator or in the direct sunlight;
- Protect the display unit and the weighing plate against direct draft from open windows or doors.
- Avoid jarring during weighing;
- Protect the display unit and the weighing plate against high humidity, vapours and dust.
- Do not expose the display unit to extreme dampness for longer periods of time. Non-permitted condensation (condensation of air humidity on the appliance) may occur if a cold appliance is taken to a considerably warmer environment. In this case, acclimatize the disconnected appliance for approx. 2 hours at room temperature.
- Avoid static charge of goods to be weighed or weighing container.

Major display deviations (incorrect weighing results) may be experienced should electromagnetic fields (e.g. due to mobile phones or radio equipment), static electricity accumulations or instable power supply occur. Change location or remove source of interference.

6.2 Unpacking/installation

Carefully remove the display unit from packaging, remove plastic cover and place it in the designated work area.

Mount the display unit in a way that facilitates operation and where it is easy to see. Push support base in guide rail [11] up to end stop [12], see chap. 2.

6.3 Scope of delivery / serial accessories:

- Display Unit
- Platform
- Mains adapter
- Operating manual

Accurate weighing results require a balance with perfect horizontal alignment. During initial installation and after each change of work area it is necessary to level the balance.









6.4 Mains connection

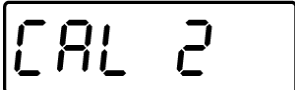

Power is supplied via the external mains adapter. The stated voltage value must be the same as the local voltage. Only use original KERN mains adapters. Using other makes requires consent by KERN.

6.5 Adjustment

As the acceleration value due to gravity is not the same at every location on earth, each display unit with connected weighing plate must be coordinated - in compliance with the underlying physical weighing principle - to the existing acceleration due to gravity at its place of location (only if the weighing system has not already been adjusted to the location in the factory). This adjustment process must be carried out for the first commissioning, after each change of location as well as in case of fluctuating environment temperature. To receive accurate measuring values it is also recommended to adjust the display unit periodically in weighing operation.

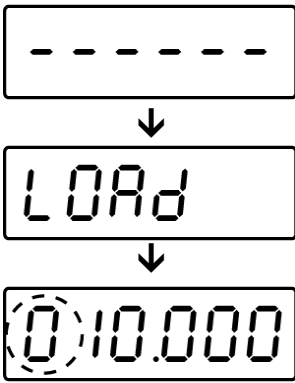
- i**
- The adjustment weight to be used depends on the capacity of the weighing system. Carry out adjustment as near as possible to the weighing system's maximum weight. Info about test weights can be found on the Internet at: <http://www.kern-sohn.com>.
 - Observe stable environmental conditions. Stabilisation requires a certain warm-up time.

<p>Press  and  at the same time in weighing mode. [ECF 1] is displayed.</p>	
<p>(The adjustment process can be exited at any time with . The balance returns then to weighing mode.)</p>	
<p>Confirm display of [ECF 1] with . [CAL Z] is displayed.</p>	
<p>Acknowledge with . [-----] followed by [LOADⁱ] will be displayed briefly. Then the display to input the recommended adjustment weight is displayed (see chap. 1 "Technical data") The left digit flashes. Enter the value of the adjustment weight as follows: Switch to the next digit to the right with . Increase number with . Confirm the value entered with .</p>	 <p>(example)</p>

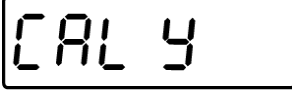
The specified adjustment weight is displayed flashing.	 (example)
Place the adjustment weight centrally on the weighing plate and confirm with  . "CAL Y" will flash briefly and a signalling tone will sound. Adjustment will be performed. Then the balance returns automatically into the weighing mode.	

i An error message will be displayed in the event of an adjustment error or incorrect adjustment weight. Remove the adjustment weight and repeat the adjustment process.

Keep the adjustment weight close to the balance. Daily control of the weighing exactness is recommended for quality-relevant applications.

7 Operation

7.1 Start-up

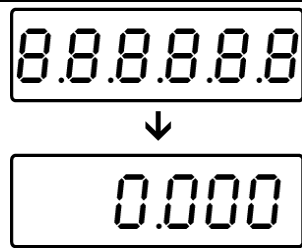
<p>Start balance by pressing .</p> <p>The balance will carry out a self-test. As soon as the weight display appears, the balance is ready for weighing.</p>	
--	---

Should the balance not display exactly zero despite empty scale pan, press the  button. The balance will be set to zero after a short standby time.

7.2 Switching Off

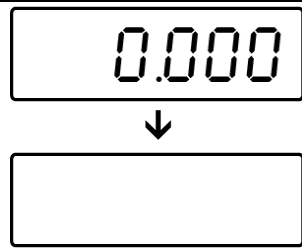
<p>Switch off balance with , the display will go off.</p>	
---	--

7.3 Zeroing

Resetting to zero corrects the influence of light soiling on the weighing plate.

⇒ To unload the weighing system

⇒ Press , the zero display appears.

7.4 Simple weighing

⇒ Place goods to be weighed on balance.

⇒ Wait for stability display [O].

⇒ Read weighing result.





Overload warning

Overloading exceeding the stated maximum load (max) of the device, minus a possibly existing tare load, must be strictly avoided. This could damage the instrument.



Exceeding maximum load is indicated by the display of „LLLLLL“, and a signal sound. Unload weighing system or reduce preload.

7.5 Weighing with tare

Place an empty weighing container, the weight of the weighing container will be displayed.	
Press  , the zero display appears. The indicator [NET] is displayed. The tare weight is saved until it is deleted.	
Weigh the material, the net weight will be indicated. The taring process can be repeated any number of times, e.g. when adding several components for a mixture (adding). The limit is reached when the whole weighing range is exhausted. After removing the weighing container, the weight of the weighing container appears as negative display. The tare weight is saved until it is deleted.	
Delete tare value: Unload the balance and press  , zero display will appear.	

7.6 Hold function (animal weighing function)

The balance has an integrated animal weighing function (mean value calculation). Using this function it is possible to weigh domestic or small animals exactly (min. load 1% of the max. one), although they do not stand quiet on the weighing plate.

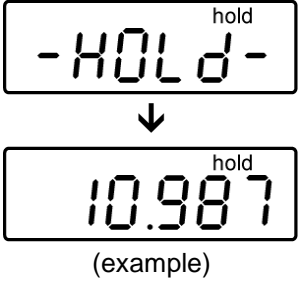

<p>Place weighing goods and press . The display will be blinking [-HOLD-] and the indicator [hold] appears. During this time the balance takes up several measured values and displays then the calculated mean value.</p> <p>This value will be displayed until you press  again. The indicator [hold] turns off, the balance will return to the normal weighing mode.</p> <p>By pressing  again, this function can be repeated any number of times.</p>	 <p>(example)</p>
--	--







There is no average value calculation in the event of too much movement (heavy display oscillation).

8 Menu

8.1 Navigation in the menu

⇒ Press  and  at the same time in weighing mode. [UF 1] is displayed.

⇒ Press  as often as necessary until the required function is displayed.

⇒ Confirm selected function by . The current setting will be displayed. Select the desired parameter with  . Return to menu by .

⇒ Press  to exit the menu. The balance returns automatically into weighing mode.

8.2 Menu overview

UF-1	- 1630 (example)	Internal value not documented	
UF-2	RoFF 10 *	Auto-Off Automatic shutdown function Can be set between 1-99 minutes	
UF-3		Display background illumination Adjustable:	
	Lit on	Background lighting on:	
	Lit off	Background lighting off	
	Lit R *	Backlight turns off automatically	
		Hold function (animal weighing function) Adjustable:	
	Hd 20d	Average value is calculated for unstable weighing conditions from approx. 20 d	
	Hd 5d	Average value is calculated for unstable weighing conditions from approx. 5 d	
	Hd 10d *	Average value is calculated for unstable weighing conditions from approx. 10 d	
UF-5	ZP 0 ↓ ZP 5	Auto Zero Adjustable:	
		ZP 0 *	Auto Zero: Off
		ZP 1	• 0.5 d/s
		ZP 2	• 1 d/s
		ZP 3	• 2 d/s
		ZP 4	• 3 d/s
		ZP 5	• 5 d/s
UF-6	9.79450 *	G-value (value of the local gravitational acceleration) Adjustable	

i Factory settings are marked by *.

9 Servicing, maintenance, disposal

9.1 Cleaning

Before cleaning, disconnect the appliance from the operating voltage.

Please do not use aggressive cleaning agents (solvents or similar agents), but a cloth dampened with mild soap suds. Take care that the device is not penetrated by fluids and polish it with a dry soft cloth.

9.2 Servicing, maintenance

The appliance may only be opened by trained service technicians who are authorized by KERN.

Before opening, disconnect from power supply.

9.3 Disposal

Disposal of packaging and appliance must be carried out by operator according to valid national or regional law of the location where the appliance is used.

10 Error messages, troubleshooting guide

In case of an error in the program process, briefly turn off the appliance and disconnect from power supply. The weighing process must then be restarted from the beginning.

Fault	Possible cause
The displayed weight does not glow.	<ul style="list-style-type: none">• The appliance is not switched on.• Mains power supply interrupted (mains cable defective).• Power supply interrupted.• (Rechargeable) batteries are inserted incorrectly or empty• No (rechargeable) batteries inserted.
The displayed weight is permanently changing	<ul style="list-style-type: none">• Draught/air movement• Table/floor vibrations• Weighing pan has contact with other objects.• Electromagnetic fields / static charging (choose different location/switch off interfering device if possible)
The weighing result is obviously incorrect	<ul style="list-style-type: none">• The display of the balance is not at zero• Adjustment is no longer correct.• Great fluctuations in temperature.• Warm-up time was ignored.• Electromagnetic fields / static charging (choose different location/switch off interfering device if possible)

Error message	Possible cause
<i>o-Err</i>	<ul style="list-style-type: none">• Weighing range exceeded
<i>u-Err</i>	<ul style="list-style-type: none">• Insufficient preload, e. g. missing weighing pan
<i>b-Err</i>	<ul style="list-style-type: none">• Missing internal memory
<i>1-Err</i>	<ul style="list-style-type: none">• Incorrect adjusting weight
<i>2-Err</i>	<ul style="list-style-type: none">• Inappropriate adjustment
<i>l-Err</i>	<ul style="list-style-type: none">• Item weight too low

Should other error messages occur, switch device off and then on again. If the error message remains inform manufacturer.

11 Declaration of conformity

The current EC/EU Conformity declaration can be found online in:

www.kern-sohn.com/ce

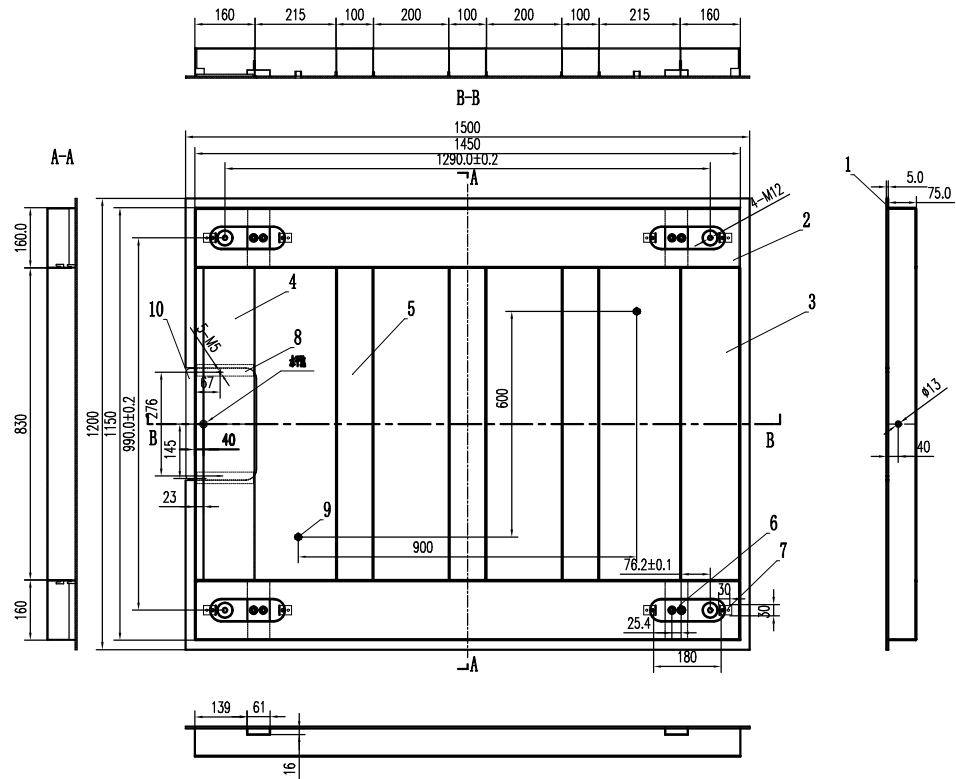

1200 x 1500

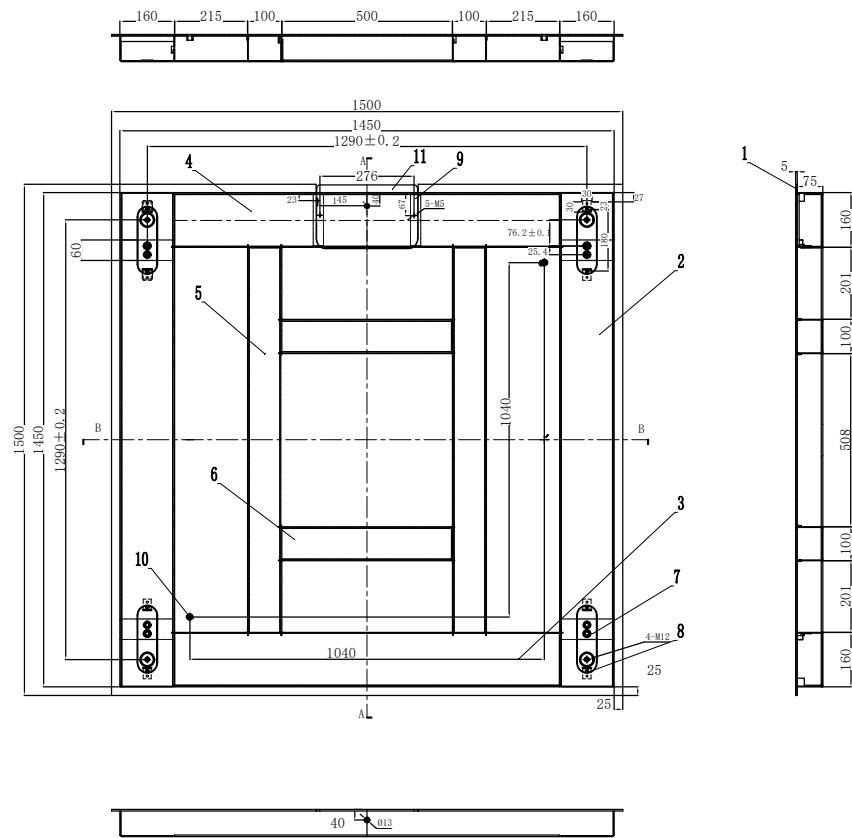

1500 x 1500